











CUBO 20



Lampada da terra / tavolo
 Anno di produzione: 1999
 Versioni: luminosa.
 Materiali: Polietilene.
 Dimensioni: 20 x 20 h 20 cm
 Peso: 0,7 Kg
 Imballaggio: 21 x 21 x 26 cm
 Volume imballaggio: 0,011 m³

Lampe de sol / de table
 Année de production: 1999
 Versions: lumineuse.
 Matériaux: Polyéthylène.
 Dimensions: 20 x 20 h 20 cm
 Poids: 0,7 Kg
 Emballage: 21 x 21 x 26 cm
 Volume emballage: 0,011 m³

Floor lamp / table lamp
 Year of production: 1999
 Versions: lighting.
 Material: Polyethylene.
 Dimensions: 20 x 20 h 20 cm
 Weight: 0,7 Kg
 Packaging: 21 x 21 x 26 cm
 Packaging volume: 0,011 m³

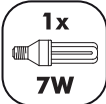
DIMENSIONS (cm)		
CODE	LP CUE021 lighting OUT        MATT FINISH €75,00+iva	
LIGHTING	1x 	 1x Energy saving bulb recommended (not included). 7W
COLOURS	LIGHTING <input type="radio"/> LIGHT WHITE (code LA)	















CUBO 30



Lampada da terra / tavolo
 Anno di produzione: 2001
 Versioni: luminosa.
 Materiali: Polietilene.
 Dimensioni: 30 x 30 h 30 cm
 Peso: 2,4 Kg
 Imballaggio: 31 x 31 x 34 cm
 Volume imballaggio: 0,033 m³

Lampe de sol / de table
 Année de production: 2001
 Versions: lumineuse.
 Matériaux: Polyéthylène.
 Dimensions: 30 x 30 h 30 cm
 Poids: 2,4 Kg
 Emballage: 31 x 31 x 34 cm
 Volume emballage: 0,033 m³

Floor lamp / table lamp
 Year of production: 2001
 Versions: lighting.
 Material: Polyethylene.
 Dimensions: 30 x 30 h 30 cm
 Weight: 2,4 Kg
 Packaging: 31 x 31 x 34 cm
 Packaging volume: 0,033 m³

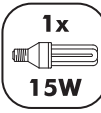
DIMENSIONS (cm)		
CODE	<p> LP CUE032 lighting OUT       MATT FINISH €95,00+iva </p> <p> LA CUB030 lighting LED       GLOSSY FINISH €145,00+iva </p>	
LIGHTING	1x 	 1x Energy saving bulb recommended (not included).
COLOURS	<p> LIGHTING <input type="radio"/> LIGHT WHITE (code LA) </p> <p> LED VERSION <input type="radio"/> LIGHT WHITE (code LA) </p> <p> KIT LED 3W RGB MULTICOLOR (incluso). Fornito con caricabatteria e telecomando (8 ore durata batteria / 10 ore ricarica) </p>	



CUBO 40



Lampada da terra / tavolo
 Anno di produzione: 2002
 Versioni: luminosa.
 Materiali: Polietilene.
 Dimensioni: 43 x 43 h 43 cm
 Peso: 4,1 Kg
 Imballaggio: 46 x 46 x 47 cm
 Volume imballaggio: 0,099 m³

Lampe de sol / de table
 Année de production: 2002
 Versions: lumineuse.
 Matériaux: Polyéthylène.
 Dimensions: 43 x 43 h 43 cm
 Poids: 4,1 Kg
 Emballage: 46 x 46 x 47 cm
 Volume emballage: 0,099 m³

Floor lamp / table lamp
 Year of production: 2002
 Versions: lighting.
 Material: Polyethylene.
 Dimensions: 43 x 43 h 43 cm
 Weight: 4,1 Kg
 Packaging: 46 x 46 x 47 cm
 Packaging volume: 0,099 m³

DIMENSIONS (cm)		
CODE	<p>LP CUE042 lighting OUT</p> <p>LA CUB040 lighting LED</p>	<p> MATT FINISH €105,00+iva </p> <p> GLOSSY FINISH €160,00+iva </p>
LIGHTING	<p>1x </p>	<p>1x Energy saving bulb recommended (not included).</p>
COLOURS	<p>LIGHTING LED VERSION</p> <p><input type="radio"/> LIGHT WHITE (code LA) <input type="radio"/> LIGHT WHITE (code LA)</p> <p>KIT LED 3W RGB MULTICOLOR (incluso). Fornito con caricabatteria e telecomando (8 ore durata batteria / 10 ore ricarica)</p>	



CUBO 50



Lampada da terra
 Anno di produzione: 2007
 Versioni: luminosa.
 Materiali: Polietilene.
 Dimensioni: 50 x 50 h 60 cm
 Peso: 8 Kg
 Imballaggio: 51 x 51 x 62 cm
 Volume imballaggio: 0,161 m³

Lampe de sol
 Année de production: 2007
 Versions: lumineuse.
 Matériaux: Polyéthylène.
 Dimensions: 50 x 50 h 60 cm
 Poids: 8 Kg
 Emballage: 51 x 51 x 62 cm
 Volume emballage: 0,161 m³

Floor lamp
 Year of production: 2007
 Versions: lighting.
 Material: Polyethylene.
 Dimensions: 50 x 50 h 60 cm
 Weight: 8 Kg
 Packaging: 51 x 51 x 62 cm
 Packaging volume: 0,161 m³

DIMENSIONS (cm)	<p style="text-align: center;">NOTE: <u>IRREGULAR CUBE</u></p>	
CODE	<p>LP CUE051 lighting OUT MATT FINISH €160,00+iva</p> <p>LA CUB050 lighting LED GLOSSY FINISH €210,00+iva</p>	
LIGHTING	<p>1x </p>	<p> Energy saving bulb recommended (not included).</p>
COLOURS	<p>LIGHTING LED VERSION</p> <p><input type="radio"/> LIGHT WHITE (code LA) <input type="radio"/> LIGHT WHITE (code LA)</p> <p>KIT LED 3W RGB MULTICOLOR (incluso). Fornito con caricabatteria e telecomando (8 ore durata batteria / 10 ore ricarica)</p>	



CUBO 75











Lampada da terra
 Anno di produzione: 2005
 Versioni: luminosa.
 Materiali: Polietilene.
 Dimensioni: 73 x 73 h 73 cm
 Peso: 20 Kg
 Imballaggio: 80 x 80 x 80 cm
 Volume imballaggio: 0,512 m³

Lampe de sol
 Année de production: 2005
 Versions: lumineuse.
 Matériaux: Polyéthylène.
 Dimensions: 73 x 73 h 73 cm
 Poids: 20 Kg
 Emballage: 80 x 80 x 80 cm
 Volume emballage: 0,512 m³

























Floor lamp
 Year of production: 2005
 Versions: lighting.
 Material: Polyethylene.
 Dimensions: 73 x 73 h 73 cm
 Weight: 20 Kg
 Packaging: 80 x 80 x 80 cm
 Packaging volume: 0,512 m³

DIMENSIONS (cm)		
CODE	<p>LP CUE076 lighting OUT</p> <p>MATT FINISH €460,00+iva</p>	
LIGHTING	<p>1x</p>	<p>1x</p> <p>Energy saving bulb recommended (not included).</p>
COLOURS	<p>LIGHTING</p> <p><input type="radio"/> LIGHT WHITE (code LA)</p>	



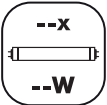







SYMBOLS

 For indoor use.	 Stackable item.	 Conformity to the European Community instructions.
 For indoor and outdoor use.	 100% recyclable polyethylene.	 Recycling and disposal of electronic waste (WEEE).
 Outdoor version on request (IP55).	 European Community registered model.	

LIGHTING SYMBOLS

 Protected against the intrusion of solid objects $\varnothing > 12$ mm, not against water.	 Standard lamp base for E27 - 27 mm light bulb.	 RGB lighting system.
 Protected against the intrusion of solid objects $\varnothing > 1$ mm and splashing water.	 Lamp base for G4 halogen bulb.	 Item compatible with Candy Light.
 Protected against the intrusion of dust and water jets.	 Lamp base for GU10 spotlight.	 Insulation class 1.
 Fully protected against the intrusion of dust and immersion in water.	 Lamp base for G13 neon tube.	 Insulation class 2.
 Small lamp base for E14 - 14 mm light bulb.	 Neon tube lighting system.	 Insulation class 3.
 Medium lamp base for E26 - 26 mm light bulb.	 LED technology lighting system.	 Device proper to direct assembly onto normally inflammable surfaces.
 Lighting through energy saving bulb. The upper figure shows the number of allowed bulbs. The lower figure shows the MAXIMUM recommended power.	 Lighting through energy saving fluorescent spotlight. The upper figure shows the number of allowed spotlights. The lower figure shows the MAXIMUM recommended power.	
 Lighting through neon tube. The upper figure shows the number of allowed neon tubes. The lower figure shows the MAXIMUM recommended power.	 Lighting through energy saving globe bulb. The upper figure shows the number of allowed bulbs. The lower figure shows the MAXIMUM recommended power.	
 Lighting through flexible LED tube. The lower figure shows the MAXIMUM recommended power.	 Lighting through circular T9 neon tube. The upper figure shows the number of allowed neon tubes. The lower figure shows the MAXIMUM recommended power.	

WIRING SYMBOLS

 Wiring with metal clamp. IP20 protection. Diameter 11 cm.	 Wiring with special base for KIT LED 3 WATT. IP55 protection. Diameter 11,6 cm.
 Wiring with metal base. IP55 protection. Diameter 10 cm. Fastening by hex screw key.	 Wiring with plastic screw base. I3 - IP20 protection. E3 - IP55 protection. Diameter 6 cm.
 Wiring with metal base. IP55 protection. Diameter 20 cm. Fastening by hex screw key.	 Wiring with plastic screw base. I3 - IP20 protection. E3 - IP55 protection. Diameter 10 cm.
 Wiring with plastic base and metal inserts. I2 - IP20 protection. E2 - IP55 protection. Diameter 10 cm. Fastening by slot screwdriver.	 Wiring with plastic screw base. I3 - IP20 protection. E3 - IP55 protection. Diameter 15 cm.
 Wiring with plastic base and LED CANDY LIGHT. IP44 protection. Diameter 10 cm.	 Special metal base. IP20 protection. Several sizes.